

Porte in Legno



CATALOGO
2024



Indice

05	INDICE	66	PIANTE
06	AZIENDA	72	SALVASPAZIO
09	SOSTENIBILITÀ	74	A LIBRO ASIMMETRICA
12	MADE IN ITALY	76	SCORREVOLE INTERNA
15	SICUREZZA	78	SCORREVOLE ESTERNA
16	LACCATI	80	A BATTENTE INVERSO
18	FIORI	82	FILOMURO
22	VULCANI	84	CON BOISERIE
26	LAGHI	86	SPORTELLI E BOTOLE
30	FIUMI	88	ACCESSORI
38	MARI	90	MANIGLIE
44	LAMINATI	92	DETTAGLI TECNICI
46	TOPLAM	94	APERTURE
50	REVERLAM COMBI	96	TELAI
56	INCONTRI	100	CONTATTI
62	BASIC		

Azienda

La Trezeta nasce nel 2008 dalla collaborazione di due aziende toscane che uniscono le loro decennali esperienze.

L'azienda si pone come obiettivo principale la realizzazione di un prodotto che unisca i toni caldi della lavorazione artigianale, alla garanzia di qualità delle materie prime utilizzate, reperite nel territorio italiano ed interamente certificate.

Il risultato è una vasta gamma di porte da interni e di porte blindate di alta qualità per soddisfare ogni tipo di esigenza.





Sostenibilità



Impegno Green: Innovazione e Sostenibilità

Nella nostra azienda, l'innovazione si incontra con la sostenibilità per offrirti prodotti che non solo abbelliscono il tuo spazio, ma lo fanno con il minimo impatto ambientale

Orgogliosamente, abbiamo intrapreso un significativo percorso verso l'autosufficienza energetica, investendo in un avanzato impianto fotovoltaico che alimenta la nostra produzione, riducendo l'impronta di carbonio di ogni prodotto che creiamo.

Inoltre, il nostro impegno verso la sostenibilità si estende all'utilizzo di materiali certificati FSC® (Forest Stewardship Council FSC®), sostenendo la biodiversità e le comunità locali. Scegliendo i nostri prodotti, partecipi attivamente alla promozione di un futuro più verde e sostenibile, senza compromessi sulla qualità e sul design.



Il marchio della
gestione forestale
responsabile



Made in Italy

La Trezeta offre ai propri clienti un'ampia gamma di prodotti e servizi, con l'obiettivo di fornire una soluzione efficace in termini di design e qualità.

L'esperienza da oltre 50 anni di due aziende toscane nel settore del legno garantisce prodotti realizzati in modo artigianale con allo stesso tempo l'impiego delle migliori tecnologie del campo. Il risultato è la garanzia di un prodotto di qualità italiana.

Trezeta infatti unisce le caratteristiche e la resistenza del laminato, ad oggi uno dei materiali più utilizzati nel settore della costruzione degli interni, con il design e il gusto tipico dell'artigianato toscano.

L'ispirazione parte dal contesto dell'azienda, caratterizzato dalla disponibilità di materiali di pregio e alla maestria artigianale tramandata negli anni. Un made in italy bello e di gran valore.





Sicurezza

Un'ampia gamma a disposizione, l'esperienza nel settore e l'adattabilità ad ogni richiesta e progetto, sono le caratteristiche fondamentali delle porte Trezeta.

Prodotti realizzati con materiali di pregio e con le migliori tecnologie sono durevoli nel tempo e adatti a qualsiasi contesto di inserimento, che sia l'ambiente domestico o aziendale.

Tutto ciò fa sì che i nostri prodotti garantiscano una qualità eccellente e una sicurezza ineguagliabile.

Laccati

Le porte laccate Trezeta sono suddivise in 4 collezioni con stili diversi tra loro in modo da adattarsi al meglio alle varie soluzioni di design da interno.

Porte lisce o pantografate con ampia varietà di modelli e finiture, con la possibilità di creare disegni personalizzati.

Composizione anta: perimetro in abete giuntato. Interno in nido d'ape. Esterno pannello in mdf spessore 8 mm per lato con pantografatura a richiesta. Spessore totale pannello 44 mm.

Composizione stipite: in listellare di legno. Spessore 40 mm. Guarnizione inserita. Coprifilo multistrato pioppo



Laccati

Fiori



Porte con forme eleganti e al contempo classiche, adatte ad ogni tipo di ambiente.



MODELLI



COD. C201 RAL 6021



COD. C204 RAL 1013

MODELLI



COD. C206 RAL 7044



COD. C208 RAL 9010



COD. C203 RAL 9002



COD. C207 RAL 7047



COD. C213 RAL 7038



COD. C215 RAL 7031

Laccati

Vulcani



La pantografatura in stile moderno "doppia piatta" abbinata ad un disegno classico le rende uniche nel loro stile.



MODELLI



COD. DP401 RAL 1013



COD. DP402 RAL 7035

MODELLI



COD. DP404 RAL 7000



COD. DP407 RAL 2011



COD. DP406 RAL 1037



COD. DP403 RAL 7040

Laccati

Laghi



Pantografatura stilizzata per dare a queste porte uno stile leggero e armonioso ma che allo stesso tempo richiamano le forme classiche.



MODELLI



COD. P301 RAL 5024



COD. P303 RAL 1013

MODELLI



COD. P307 RAL 5017



COD. P311 RAL 7001



COD. P304 RAL 7047



COD. P306 RAL 9010



COD. P312 RAL 1003

Laccati

Fiumi

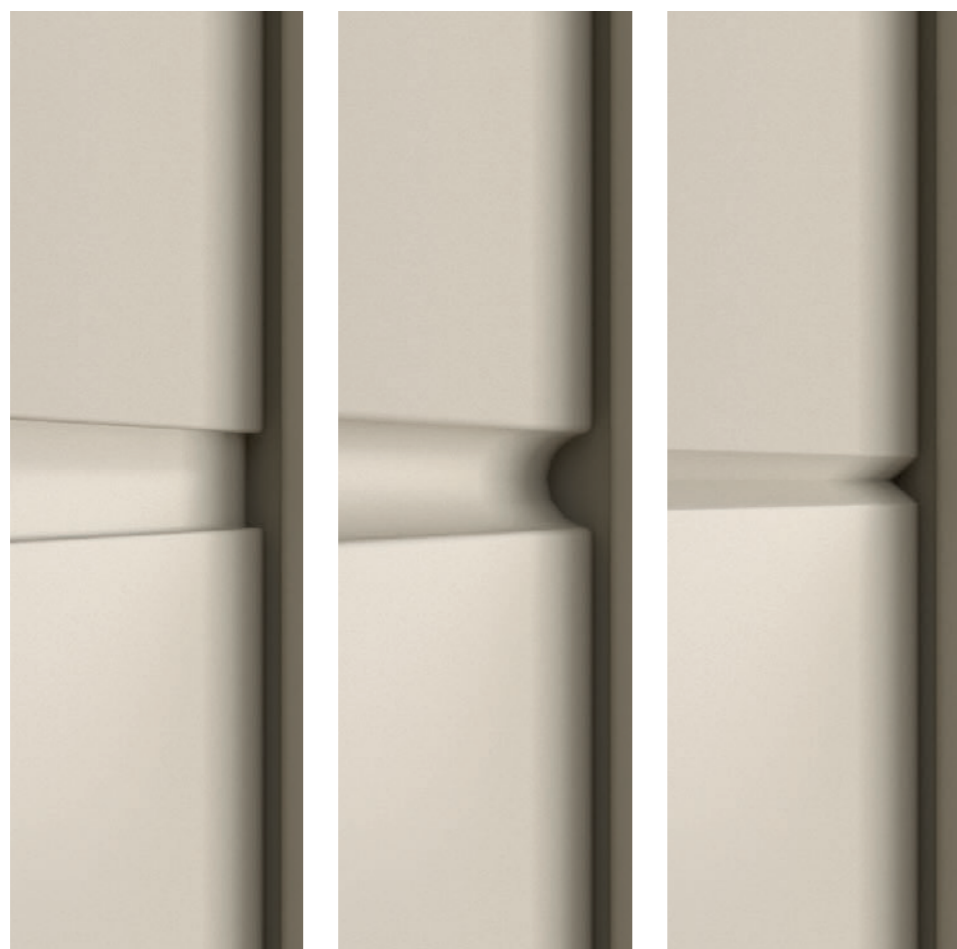

Giochi di volumi ed effetti particolari, le loro incisioni si fondono con l'arredamento in stile moderno.



MODELLI



COD. E101 RAL 3014



COD. E102 RAL 3015

MODELLI



COD. E105 RAL 4005



COD. E107 RAL 3005



COD. E103 RAL 9001



COD. E104 RAL 3003



COD. E106 RAL 4009



COD. E110 RAL 7047

MODELLI



COD. E111 RAL 7031



COD. E109 RAL 7038

MODELLI



COD. E112 RAL 7032



COD. E116 RAL 5024



COD. E113 RAL 1013



COD. E114 RAL 7040



COD. E195 RAL 9003



COD. E115 RAL 5023

MODELLI



COD. E197 RAL 6013



COD. E198 RAL 7023



COD. E199 RAL 9002



COD. E196 RAL 7001



Laccati

Mari

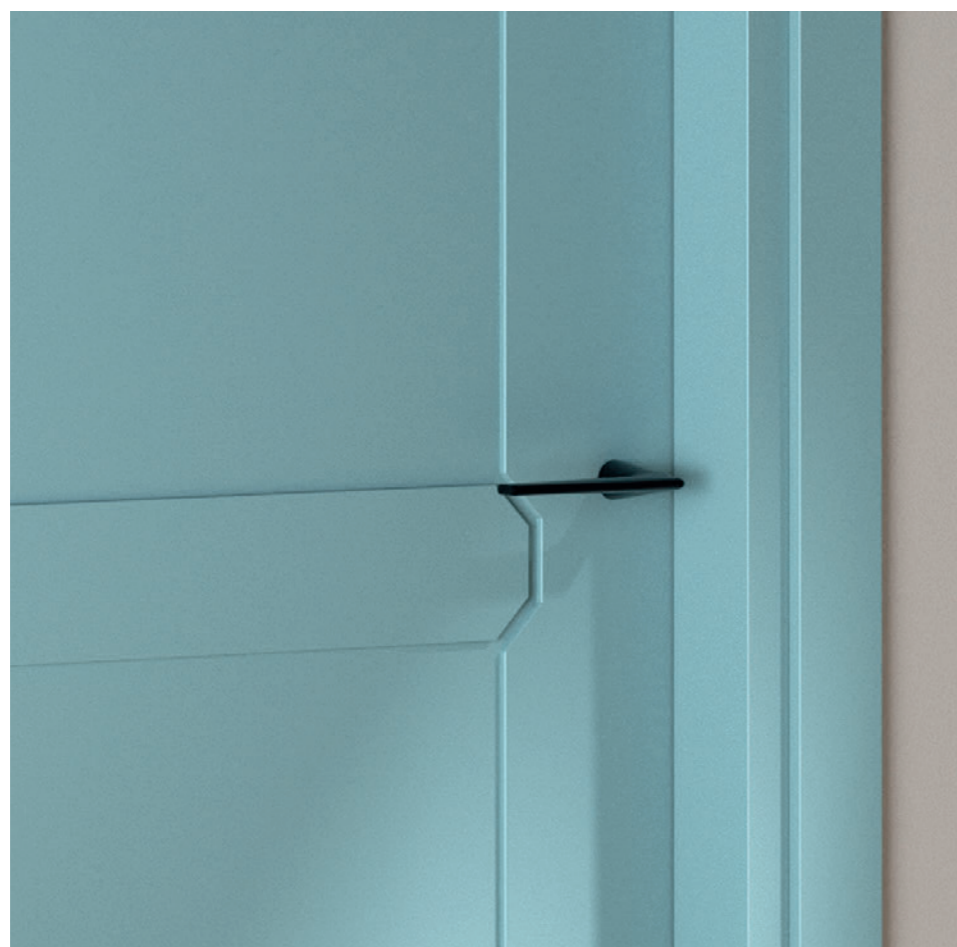

Effetti tridimensionali abbinati ad una ampia gamma di colorazioni donano a questa collezione uno stile inconfondibile nel suo genere.



MODELLI



COD. PR595 RAL 7035



COD. PR596 RAL 1007



COD. PR597 RAL 1015



COD. PR598 RAL 7044



FINITURE



INDEX 2050 NCS

RAL K7 CLASSIC



I colori rappresentati in stampa possono differire dal RAL ufficiale.



Laminati

Il laminato è un rivestimento di finitura ed è formato da molteplici strati di carta pressati gli uni sugli altri. I fogli di carta sono tenuti insieme grazie a speciali collanti. Con questa tecnica lo strato protettivo da cui sono formate le rende particolarmente resistenti a graffi ed urti. Inoltre la loro sigillatura le rende le più igieniche, evitando la penetrazione dello sporco e al contempo le rende le porte più resistenti alle infiltrazioni d'acqua.

La struttura di una porta in laminato viene realizzata in legno listellare o tamburato. Il legno listellare in listelli di legno incollati perpendicolarmente tra loro per mantenere la stabilità nel tempo, mentre il legno tamburato è costituito da una struttura a sandwich con interno alleggerito.



Laminati

Toplam



Composizione anta: tamburata con spessore di 44mm, battuta 29x10mm. Perimetro in abete giuntato (finger joint), interno in nido d'ape. Placcatura con pannelli in MDF da 4mm, rivestimento in laminato matrix o tranchè. Sezione telaio 40mm in listellare di pioppo, guarnizione in gomma.

Composizione stipite: 90x12mm ala 20mm, 63x10mm ala 20mm in multistrato di pioppo, predisposizione per il montaggio complanare o semi complanare.

Kit ferramenta: tre cerniere anuba, una serratura patent.

Incollaggio poliuretano

Trattamento Stop Water



MODELLI



COD. BIANCO MATRIX B011



COD. OLMO CENERE MATRIX 1409



COD. NOCE LK48

MODELLI



COD. RZ4033



COD. RZ4032



COD. RZ4031



COD. PALISSANDRO BLU MATRIX LM95



COD. BETON MALOJA FB02



COD. OLMO TREND PLUS 2109



COD. RZ4V



COD. RZ3V



COD. RZ1V

Laminati

Reverlam Combi

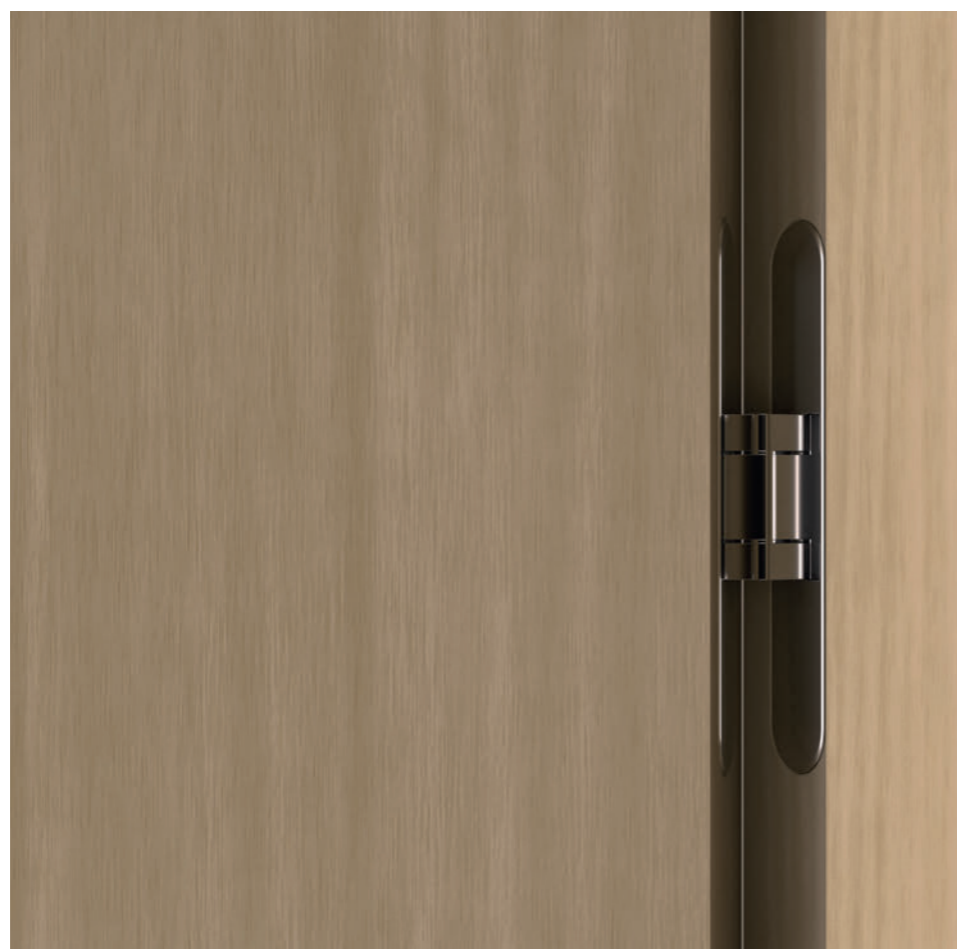

Composizione anta: tamburata con spessore di 44mm, senza battuta, reversibili speculari, complanari. Con telaio e coprifilo, perimetro in abete giuntato (finger joint), interno in nido d'ape. Placcatura con pannelli in MDF da 4mm, rivestimento in laminato matrix. Sezione telaio 40mm in listellare di pioppo, guarnizione schlegel, predisposizione per "montaggio facile".

Composizione stipite: telaio listellare o sandwich con possibilità di montaggio coprifilo complanare.

Kit ferramenta: tre cerniere a scomparsa registrabili in tre punti e reversibili, una serratura magnetica Incollaggio poliuretano.

Trattamento Stop Water



MODELLI



COD. ROVERE TRANCHÉ LM92



COD. PALISSANDRO LK55



COD. PALISSANDRO SMOKE 0711



COD. ASH



COD. GREY



FINITURE



B011 BIANCO MATRIX



B011 BIANCO ALTER



2302 PALISSANDRO BIANCO



ASH



0711 PALISSANDRO SMOKE



1409 OLMO CENERE



FB02 BETON MALOJA



LM95 PALISSANDRO BLU MATRIX

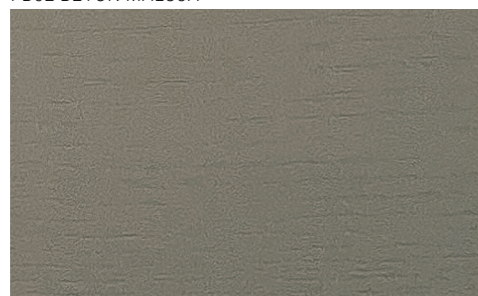

1811 TORTORA ALTER



LM92 ROVERE TRANCHE

FINITURE



2109 OLMO TREND PLUS



1309 ROVERE TRUE OAK



LK55 PALISSANDRO MATRIX



LK48 NOCE ALTER



LG69 CILIEGIO

Laminati

Incontri

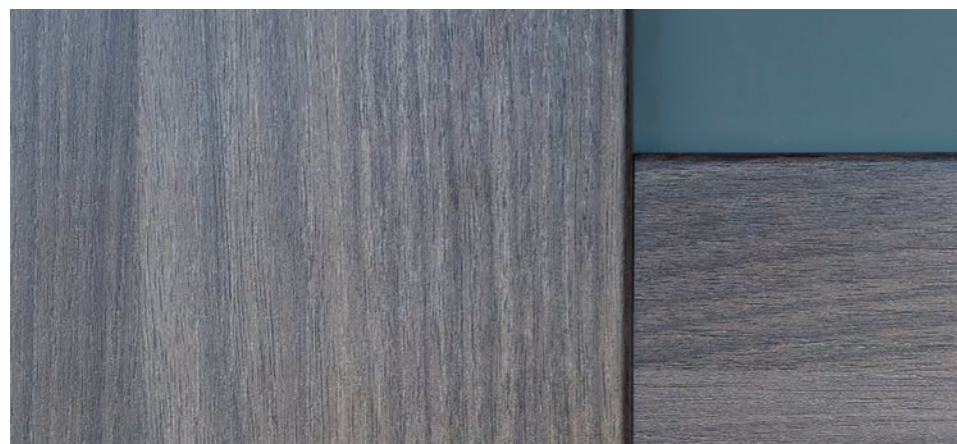

Trezeta propone questa linea di porte intelaiate, in legno massello, e modelli con inserti in vetro che possono essere adattati a qualsiasi ambiente domestico, disponibili in varie finiture. Una collezione di grande impatto con le sue forme geometriche che dinamizzano qualsiasi ambiente in cui vengono inserite.

Composizione anta: assemblata con profili in listellare di pioppo, rivestite con laminati opachi o matrix, senza battuta, reversibili speculari, complanari con telaio e coprifilo. Sezione telaio 40mm in listellare di pioppo, guarnizione schlegel, predisposizione per "montaggio facile".

Composizione stipite: 90x12 ala 20, 63x10 ala 20 in multistrato di pioppo, predisposizione per il montaggio complanare o semi complanare.

Kit ferramenta: tre cerniere a scomparsa registrabili in tre punti e reversibili, una serratura magnetica.

Incollaggio poliuretano
Trattamento Stop Water



MODELLI



COD. 2



COD. 2-4V



COD. 19-2V

MODELLI



COD. LILLY



COD. LILLY V



COD. 13



COD. 24-2P



COD. 24-1P

FINITURE



B011 BIANCO MATRIX



2302 PALISSANDRO BIANCO



FB02 BETON MALOJA



LM95 PALISSANDRO BLU MATRIX



2109 OLMO TREND PLUS



1409 OLMO CENERE



LK48 NOCE ALTER



LG69 CILIEGIO



Laminati

Basic



Composizione anta: tamburata con spessore di 44mm, battuta 29x10, perimetro in abete giuntato (finger joint), interno in nido d'ape, placcatura con pannelli in MDF da 4mm, rivestimento in laminato opaco. Sezione telaio 40mm in listellare pioppo.

Composizione stipite: 70x10 cm aletta telescopica da 20mm in multistrato di pioppo.

Kit ferramenta: tre cerniere anuba, una serratura patent.

Incollaggio poliuretano

Trattamento Stop Water



MODELLI



COD. BIANCO OPACO B011



COD. NOCE OPACO 840



COD. BIANCO PANNA OPACO B003



COD. NOCE BIONDO LD57



COD. ROVERE SBIANCATO LG23

FINITURE



B011 BIANCO



B003 PANNA



LD57 NOCE BIONDO



LD46 CILIEGIO



LG23 ROVERE SBIANCATO

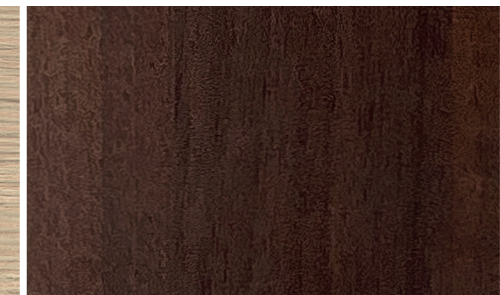

840 NOCE SCURO

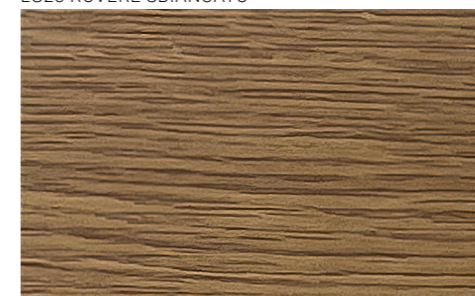

LK82 ROVERE NATURALE

Laminati

Piante

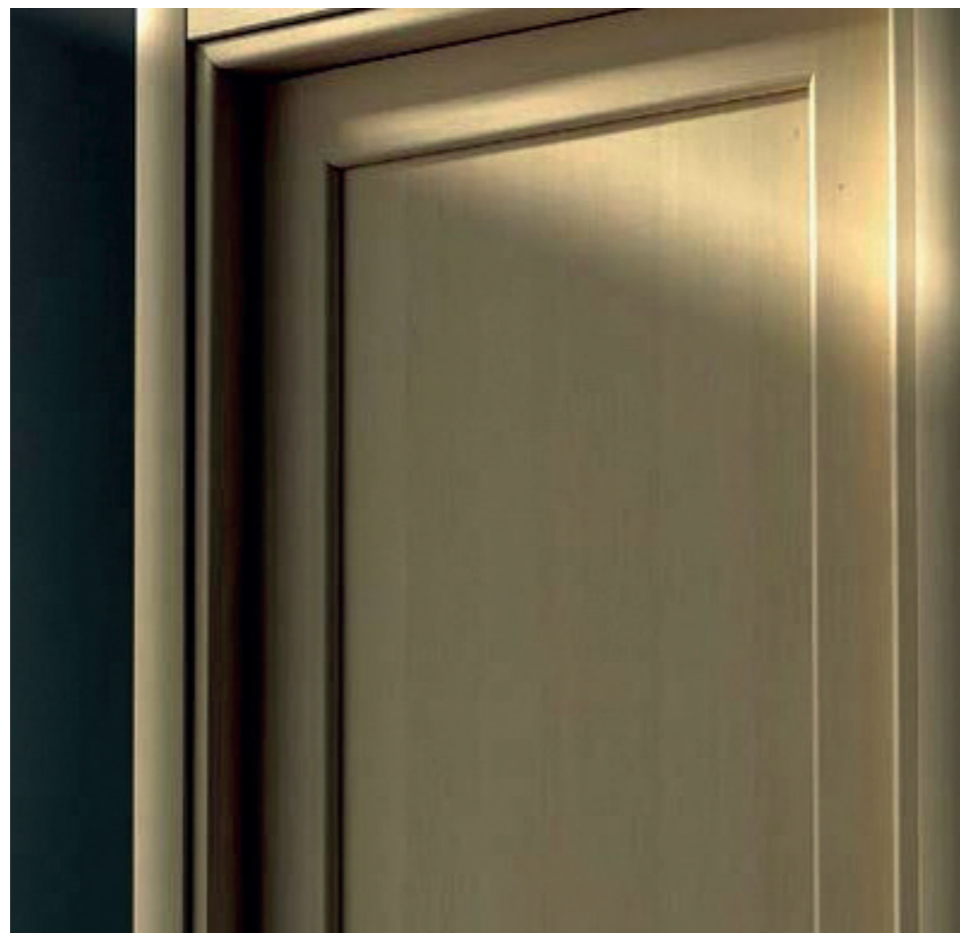

Le porte in laminato che richiamano al massello. Costruite con lo stesso criterio delle porte in legno massello, con la loro robustezza e forme classiche si adattano ad ogni tipo di ambiente.



MODELLI



COD. AZALEA BUGNA A SAPONETTA

COD. AZALEA BUGNA LISCIA

COD. AGRIFOGLIO

MODELLI



COD. OLEANDRO LISCIA

COD. PUNGITOPPO BUGNE A SAPONETTA

COD. PUNGITOPPO BUGNE LISCIE



COD. GINESTRA BUGNE A SAPONETTA

COD. GINESTRA BUGNE LISCIE

COD. OLEANDRO BUGNA A SAPONETTA



COD. VIBURNO

COD. ACANTO BUGNE A SAPONETTA

COD. ACANTO BUGNE LISCIE

MODELLI



COD. TRACHITE BUGNE A SAPONETTA



COD. TRACHITE BUGNE LISCIE



COD. CARRARA BUGNA A SAPONETTA



COD. CARRARA BUGNE LISCIE



COD. 4018 - 3V



COD. 4018 - 4V

FINITURE



B011 BIANCO



B003 PANNA

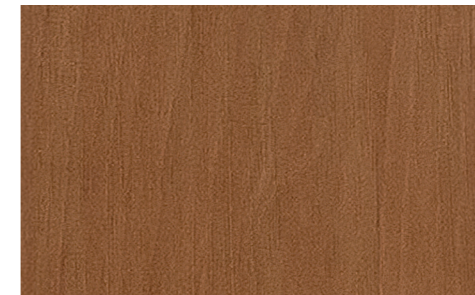

LD57 NOCE BIONDO



LD46 CILIEGIO



LG23 ROVERE SBIANCATO

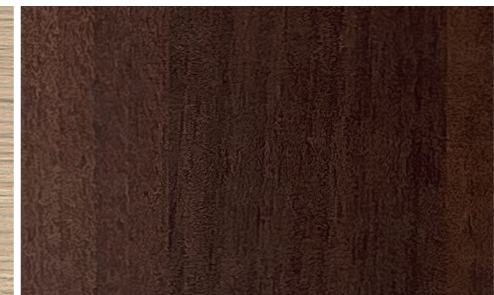

840 NOCE SCURO

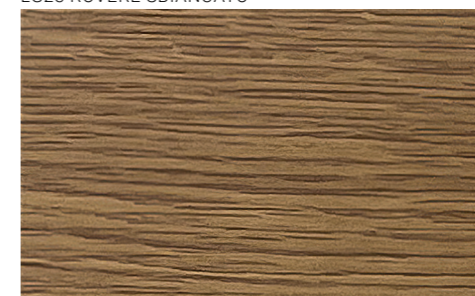

LK82 ROVERE NATURALE

Salvaspazio

Porte Salvaspazio: Funzionalità Incontra lo Stile

Le nostre porte salvaspazio rappresentano la soluzione ideale per chi cerca di ottimizzare gli spazi senza rinunciare all'eleganza. Progettate per armonizzarsi con l'arredamento di ogni ambiente, queste porte combinano ingegnosamente efficienza e design.

Grazie a meccanismi innovativi come l'apertura a scomparsa o pieghevole, massimizzano lo spazio disponibile, trasformando ogni angolo della tua casa o ufficio in un'area vivibile ed esteticamente gradevole. Con una gamma di finiture e colori, queste porte non sono solo funzionali ma diventano veri e propri pezzi di arredamento, capaci di arricchire e personalizzare il tuo spazio.



Salvaspazio

A libro asimmetrica



Porta libro salva-spazio simmetrica e asimmetrica possibile in tutte le finiture della Collezione Rz.



Salvaspazio

Scorrevole interna



Le porte scorrevoli interno parete sono la soluzione ideale per chi cerca di massimizzare lo spazio senza sacrificare lo stile, scivolando delicatamente all'interno della parete per un design fluido e minimalista.



Salvaspazio

Scorrevole esterna



Salvaspazio

A battente inverso



Design e Funzionalità

Le nostre porte a battente inverso combinano eleganza e praticità, offrendo una soluzione innovativa che si apre verso l'interno, ottimizzando lo spazio e arricchendo l'estetica dell'ambiente.



Filomuro

Porte Filomuro: Semplicità ed Eleganza

Le nostre porte filomuro si distinguono per il loro design pulito e discreto, ideate per integrarsi armoniosamente con il tuo ambiente.

Con una perfetta aderenza alla parete, queste porte offrono una soluzione elegante per chi ama gli spazi fluidi e senza interruzioni. La loro capacità di mimetizzarsi con la parete le rende una scelta ideale per ambienti moderni o minimalisti, dove il design si focalizza sull'essenzialità e sulla funzionalità.

Realizzate con attenzione ai dettagli e con materiali di qualità, le nostre porte filomuro sono sinonimo di durabilità e stile, rendendo ogni spazio più accogliente e raffinato.



Filomuro

Con boiserie



Eleganza Integrata

Le nostre porte filomuro con boiserie uniscono funzionalità a un'estetica sofisticata, offrendo una soluzione di design che integra porta e parete in un unico elemento decorativo.

La boiserie, elegante e raffinata, non solo nasconde la presenza della porta ma arricchisce l'ambiente, conferendo carattere e stile. Perfette per chi cerca un dettaglio di design distintivo, queste porte trasformano ogni passaggio in un elemento di puro fascino.



Filomuro

Sportelli e botole



Gli sportelli e le botole filomuro offrono un accesso pratico e quasi invisibile, perfetti per mantenere l'estetica pulita e la continuità delle pareti, integrandosi perfettamente con l'ambiente circostante senza comprometterne lo stile o la funzionalità.

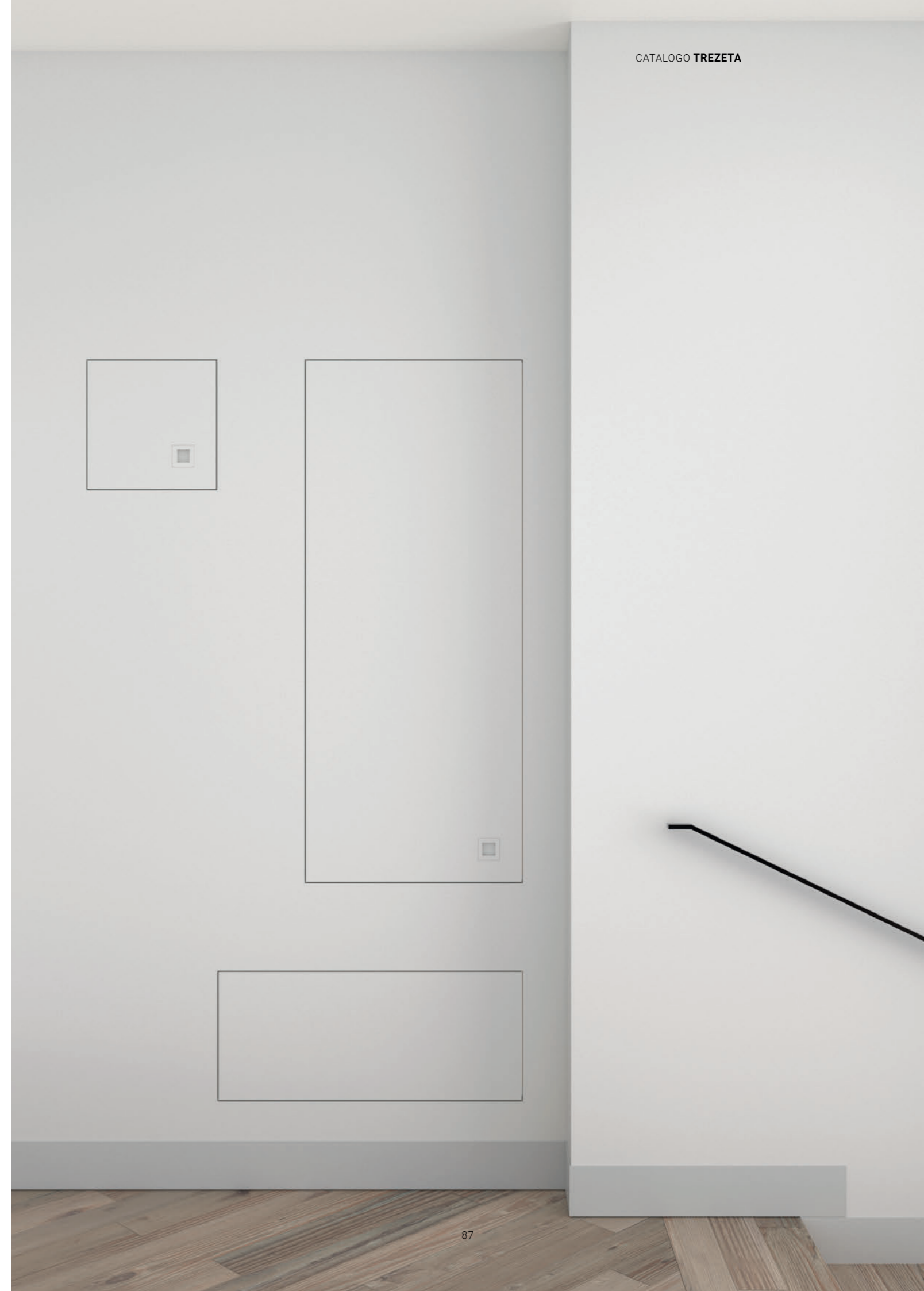

Accessori

La resa del colore dei legni e delle laccature rappresentate in questo catalogo sono da considerarsi puramente indicative. Le finiture possono subire leggere variazioni dovute anche alla naturale esposizione alla luce. La Trezeta si riserva il diritto di apportare tutte le modifiche ritenute opportune, senza obbligo di preavviso o sostituzione.



MANIGLIE



ART. GM07



ART. GM08



ART. GOCCIA



ART. QUADRA

MANIGLIE



ART. 753-Z

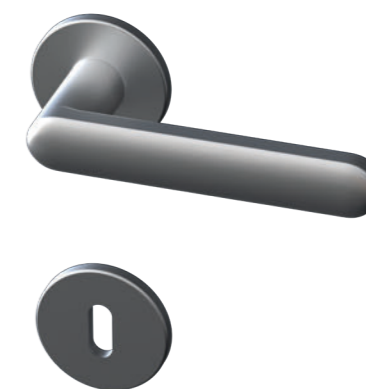

ART. 754-Z



ART. LIEVE

Ecco alcune delle nostre principali maniglie

Dettagli Tecnici

La Trezeta si riserva il diritto di apportare tutte le modifiche ritenute opportune, senza obbligo di preavviso o sostituzione.

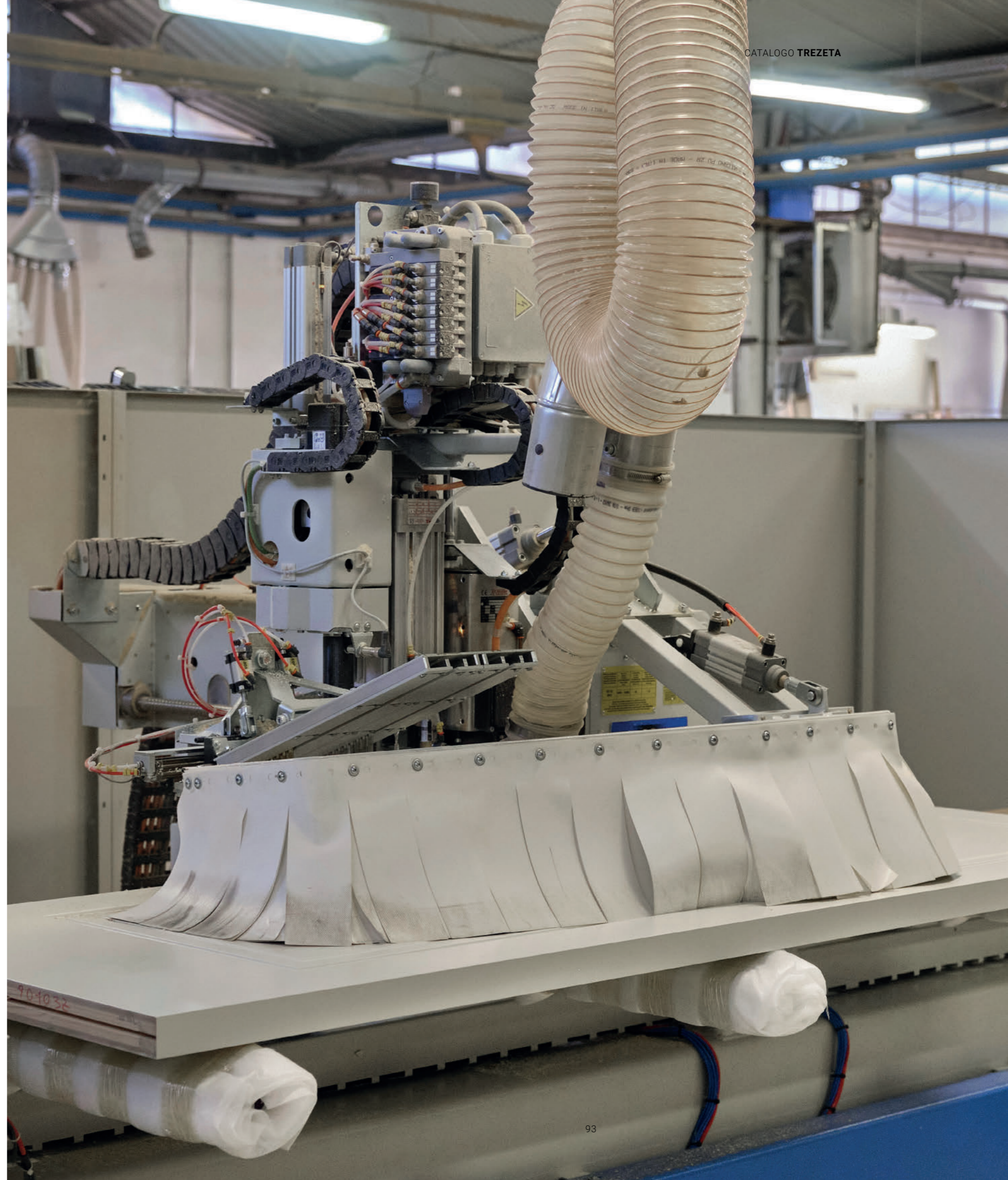

DETTAGLI APERTURE

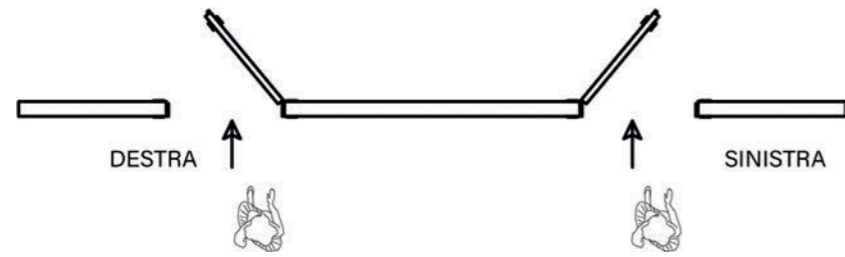

APERTURA PORTA BATTENTE



APERTURA PORTA SCORREVOLE

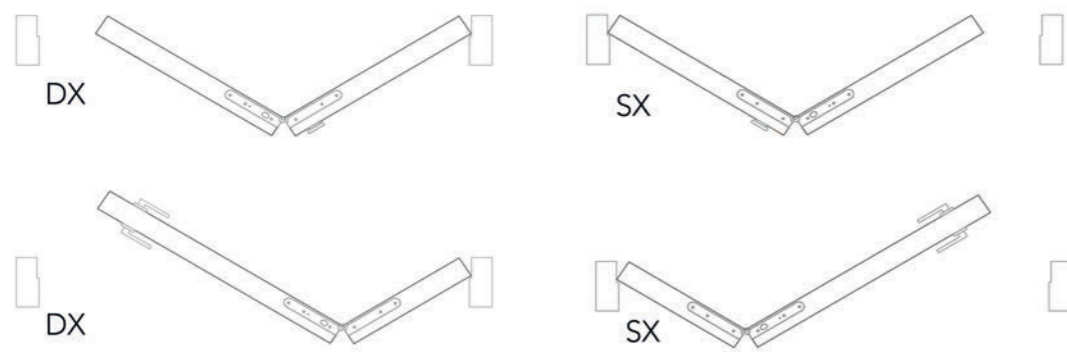

APERTURA PORTALIBRO DX

APERTURA PORTALIBRO SX

Laminated (CPL) door panel

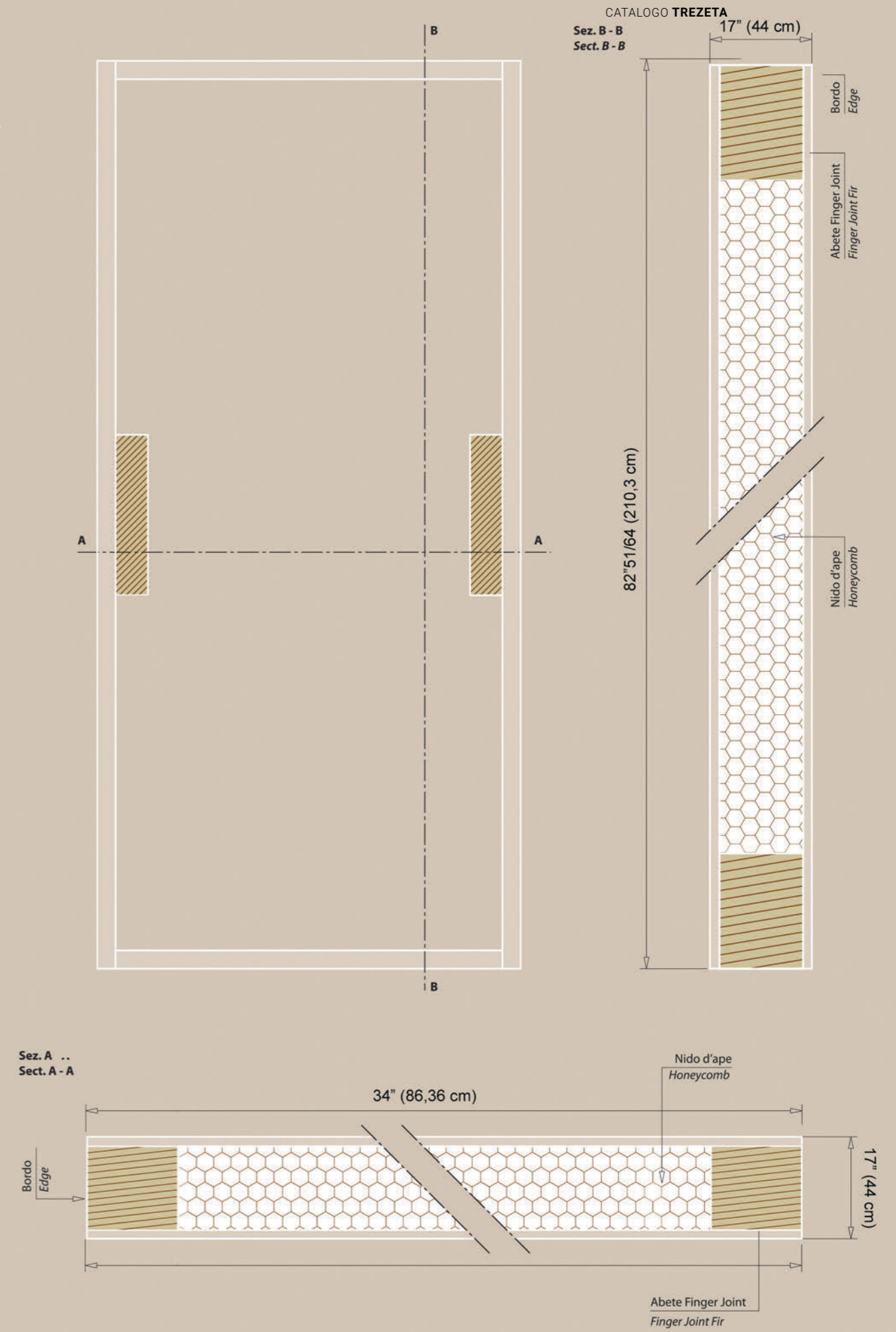

DETTAGLI TELAIO

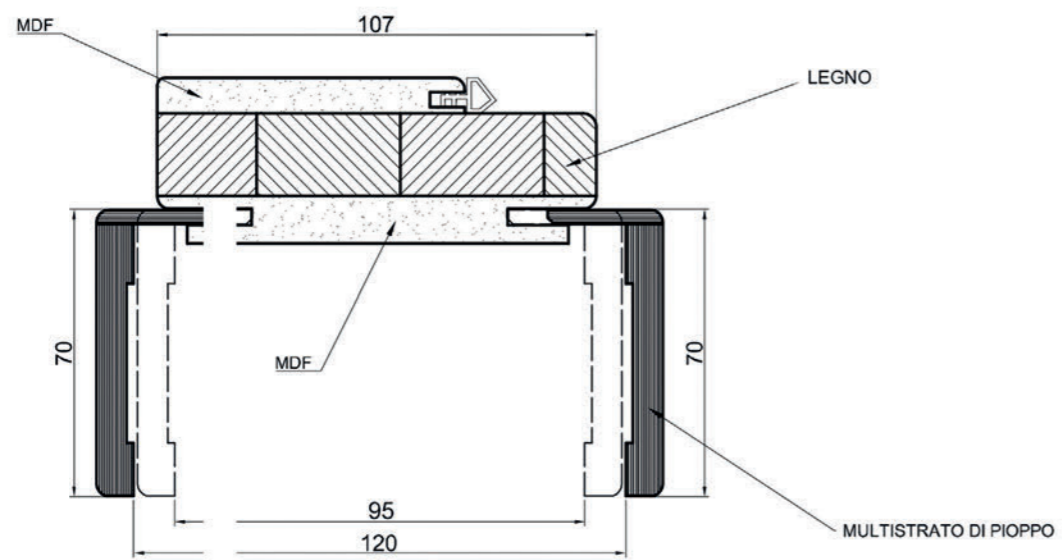

TELAIO CLASSICO SANDWICH

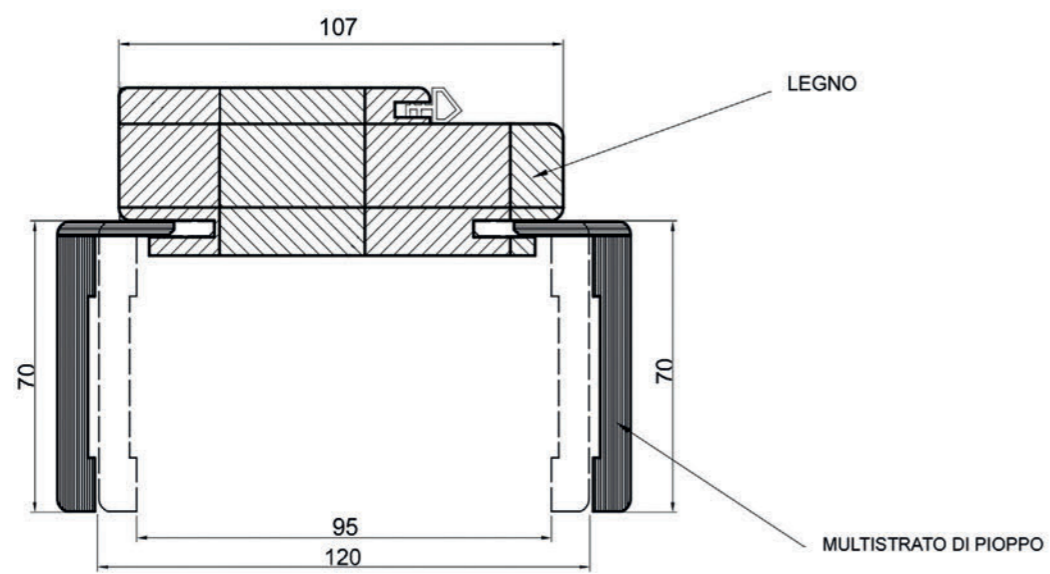

TELAIO CLASSICO LEGNO



DETTAGLI TELAIO

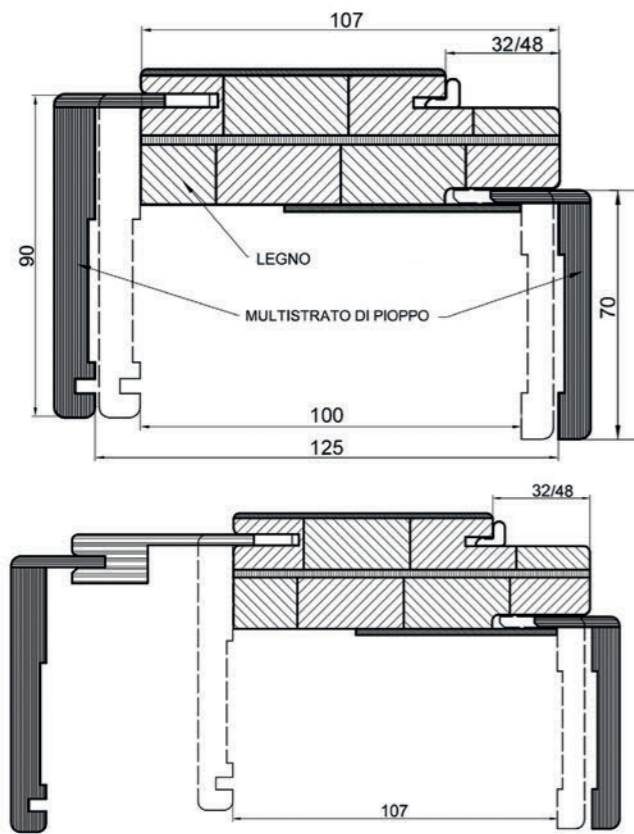

TELAIO CLASSICO SANDWICH

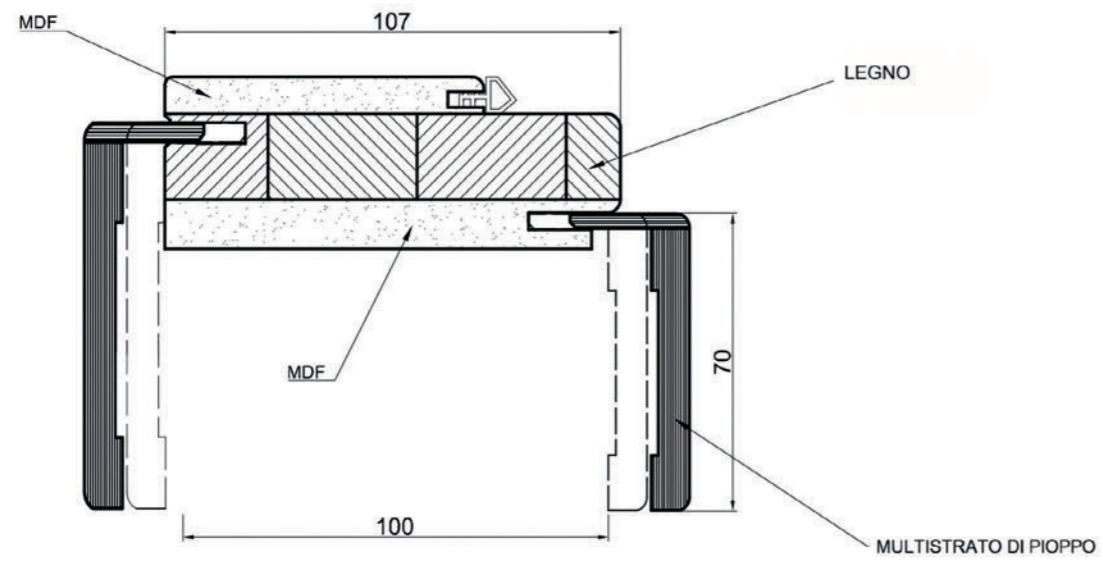

TELAIO CLASSICO LEGNO





CONTATTI

www.trezetaitaly.com
info@trezetaitaly.com
info@trezetaporte.it

S.S. Cassia Km 153
53021 Abbadia San Salvatore
Siena - Italy



S.S. Cassia Km 153
Abbadia San Salvatore
53021 Siena
Tuscany • Italy

+39 0577 778978
+39 0577 773777
info@trezetaporte.it
info@trezetaitaly.com

